

Rack Style: L-4 Base Design: B-4

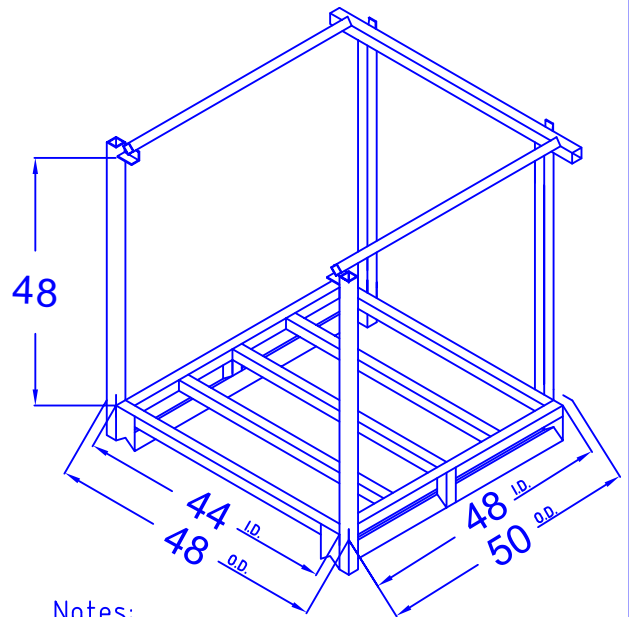
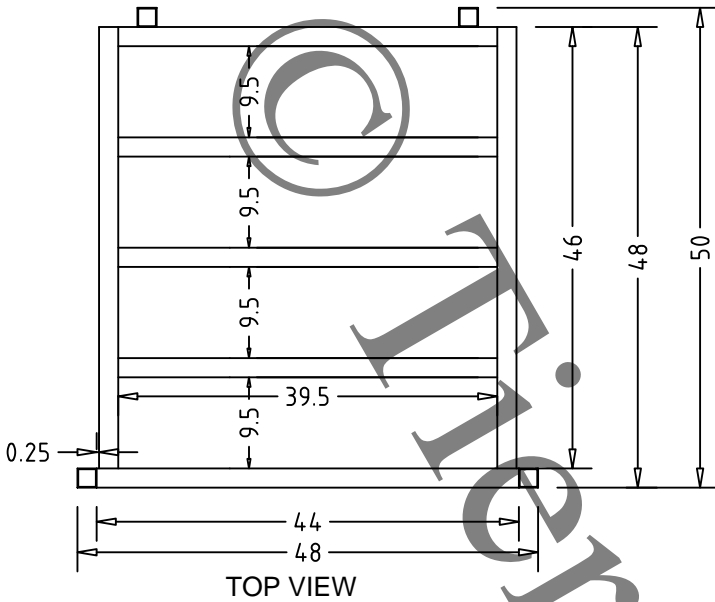

Notes:

THANK YOU FOR YOUR ORDER, PLEASE REVIEW THIS DRAWING, SIGN AND FAX TO ORDER DEPT. UPON RECEIPT WE WILL PROCESS YOUR ORDER.

SIGNATURE _____
 DATE APPROVED _____

	SIDE	FRONT	HEIGHT
RACK O.D.	50.00	X 48.00	X 56.625
RACK I.D.	48.00	X 44.00	X 48.000

CLEAR HEIGHT: 48.000
 UNDER CLEARANCE: 4.000
 LOAD SIZE: 48"X40"X48"
 4000# Capacity Stack 4 High

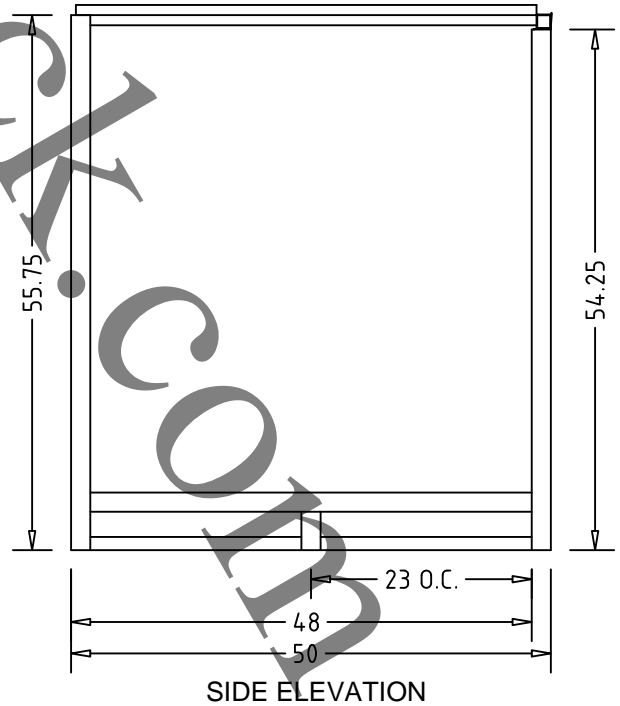
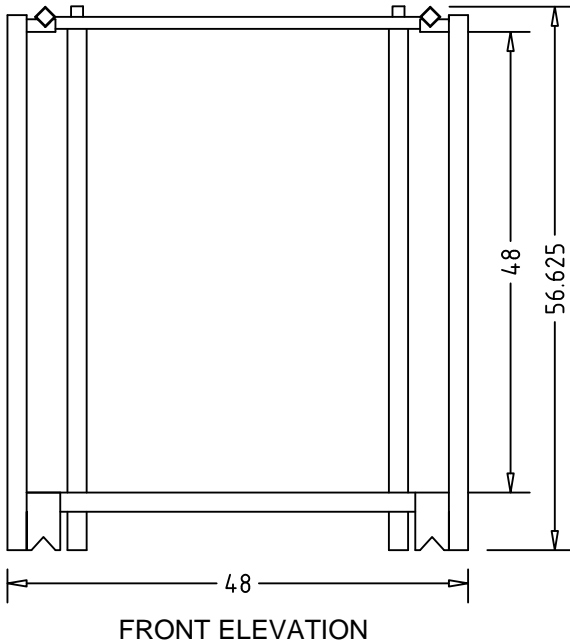

THIS DRAWING IS THE PROPERTY OF TIER-RACK CORP. AND IT IS LOANED UPON THE CONDITION THAT IT IS NOT TO BE REPRODUCED, COPIED, IN WHOLE OR IN PART BY ANY MEANS, OR RELEASED TO OTHERS WITHOUT THE EXPRESSED WRITTEN PERMISSION OF TIER-RACK CORP. THIS DRAWING IS TO BE RETURNED UPON REQUEST.

Violators will be prosecuted

Designed by EW/CC	Checked by -	Approved by - date -	Filename SC-LN4-484048	Date 11/2/05	Scale N0
TIER-RACK			BASIC.LN-4.B-4		Edition 1
					Sheet 1/