

PROPOSAL DATE:

# TIER-RACK

MODEL I-F  
Round Uprights  
PALLET STACKING FRAME

THANK YOU FOR YOUR ORDER, PLEASE REVIEW THIS DRAWING, SIGN AND FAX TO ORDER DEPT. UPON RECEIPT WE WILL PROCESS YOUR ORDER.

SIGNATURE \_\_\_\_\_  
DATE APPROVED \_\_\_\_\_

## CORNER POST Round Uprights

MINIMUM 2"  
SPACING BETWEEN  
THESE BOARDS

THIS DRAWING IS THE PROPERTY OF TIER-RACK CORP. AND IT IS LOANED UPON THE CONDITION THAT IT IS NOT TO BE REPRODUCED, COPIED, IN WHOLE OR IN PART BY ANY MEANS, OR RELEASED TO OTHERS WITHOUT THE EXPRESSED WRITTEN PERMISSION OF TIER-RACK CORP. THIS DRAWING IS TO BE RETURNED UPON REQUEST.

**Violators will be prosecuted**

NOMINAL 2 x 4" STRINGERS

NOMINAL 1 x 6" END DECKBOARDS

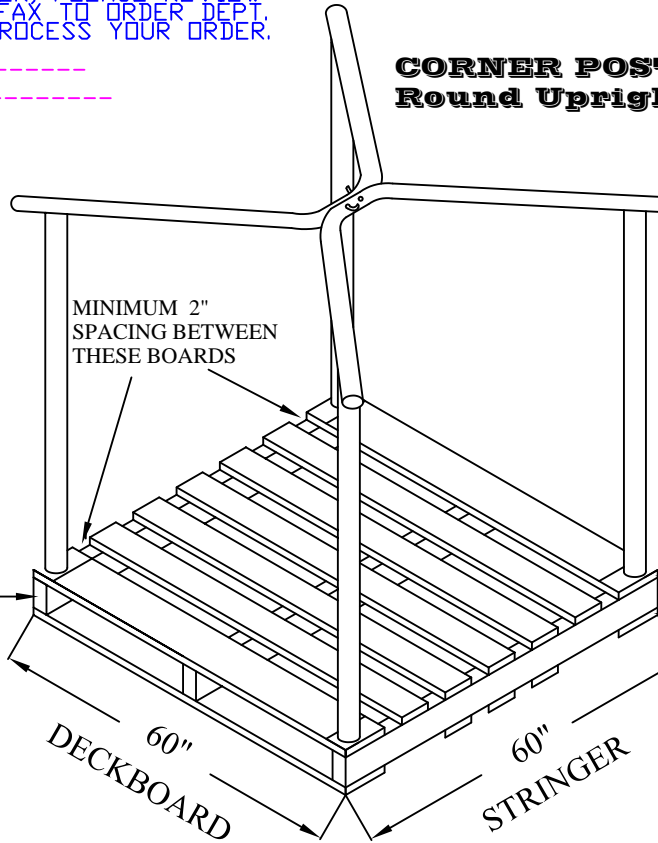

2000# CAPACITY STACKED 3 HIGH

FRONT VIEW

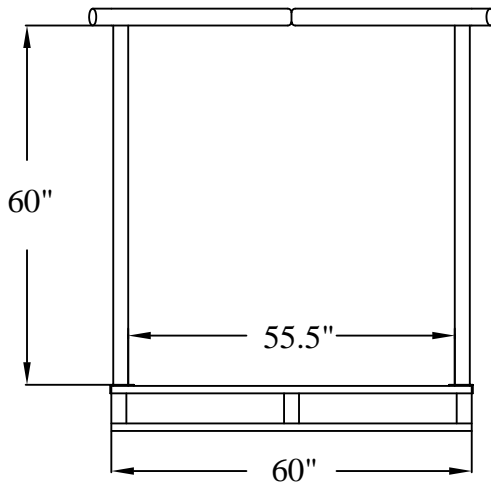

DECKBOARD

SIDE VIEW

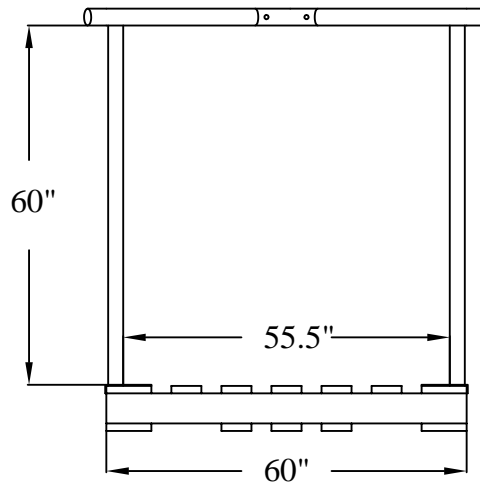

STRINGER

PREPARED FOR:  
Please Ship to:

BY: CC  
DATE: 10-28-05  
DRAWING NUMBER SC-TRF-606060L

TIER RACK CORPORATION  
425 SOVEREIGN COURT  
ST. LOUIS, MO 63011-4432  
Fax: (636) 256-4901