

PROPOSAL DATE:

TIER-RACK

MODEL I-F
Round Uprights
PALLET STACKING FRAME

THANK YOU FOR YOUR ORDER, PLEASE REVIEW THIS DRAWING, SIGN AND FAX TO ORDER DEPT. UPON RECEIPT WE WILL PROCESS YOUR ORDER.

SIGNATURE _____
DATE APPROVED _____

CORNER POST Round Uprights

MINIMUM 2"
SPACING BETWEEN
THESE BOARDS

THIS DRAWING IS THE PROPERTY OF TIER-RACK CORP. AND IT IS LOANED UPON THE CONDITION THAT IT IS NOT TO BE REPRODUCED, COPIED, IN WHOLE OR IN PART BY ANY MEANS, OR RELEASED TO OTHERS WITHOUT THE EXPRESSED WRITTEN PERMISSION OF TIER-RACK CORP. THIS DRAWING IS TO BE RETURNED UPON REQUEST.

Violators will be prosecuted

NOMINAL 2 x 4"
STRINGERS

NOMINAL 1 x 6"
END DECKBOARDS

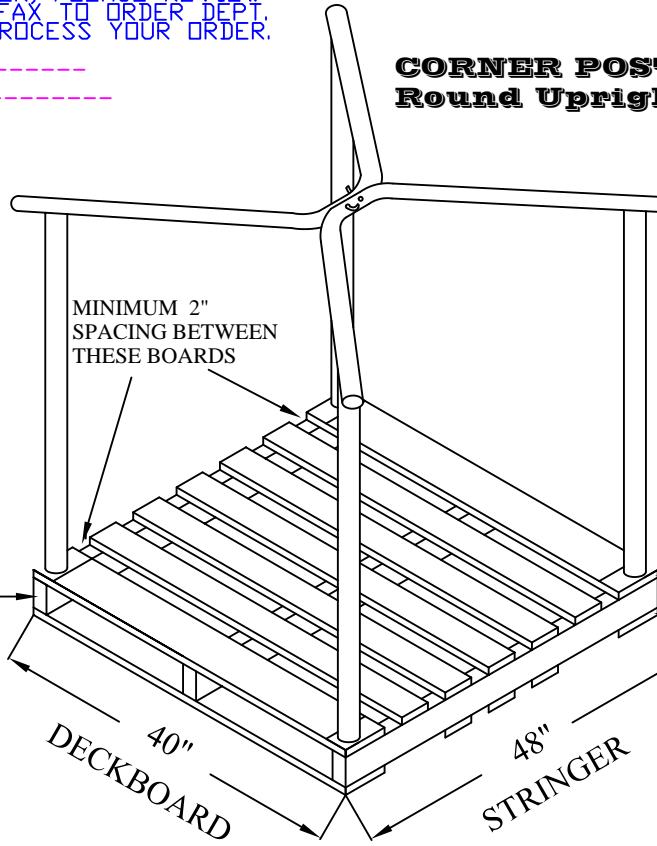

2000# CAPACITY STACKED 3 HIGH

FRONT
VIEW

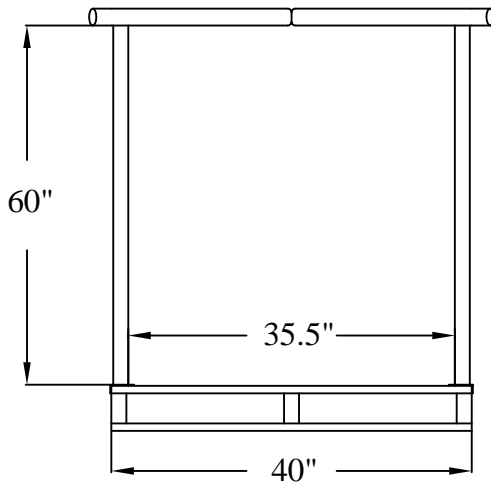

DECKBOARD

SIDE
VIEW

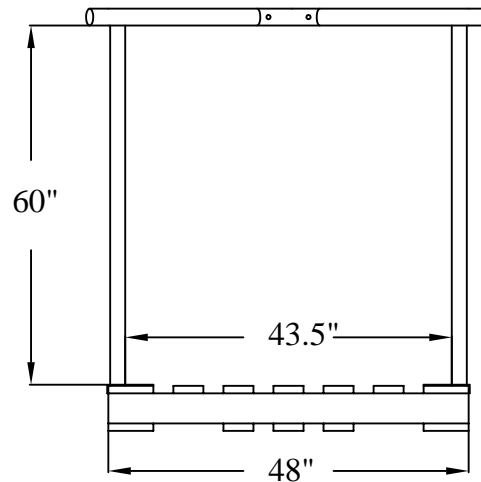

STRINGER

PREPARED FOR:
Please Ship to:

BY: CC
DATE: 10-28-05
DRAWING NUMBER SC-TRF-484060L

TIER RACK CORPORATION
425 SOVEREIGN COURT
ST. LOUIS, MO 63011-4432
Fax: (636) 256-4901